



Guide to Visual Quality of Glass in Residential Buildings

Introduction

Glass whether it be clear, tinted, or coated, supplied for buildings in New Zealand is almost exclusively manufactured using the float process, where molten glass is floated on a bed of molten tin. Glass made using this process is extremely flat, however can contain some imperfections.

The raw float glass is converted into the end product through a range of processes; cutting, edge working, and/or shaping. Common products used throughout the building industry include;

- The application of a coating to the glass surface, i.e. Low E glass.
- Laminating, where two or more panes of glass are combined each side of an interlayer, usually a PVB or EVA film.
- Toughening, where a pane of glass is heated and then quenched to increase its thermal and mechanical strength.
- Manufactured into IGU's, insulated glass units, typically in NZ, double glazing.

The intent of this guide is provide information for the assessment of glass in all buildings. The statements and tolerances are based on a mix of the applicable Standards and best industry practice. However in some cases this information maybe overwritten by specific contractual conditions.

Expectation

Most consumers believe glass to be a perfect invisible product that not only provides an uninterrupted view to the outdoors but also keeps the weather out. However, the reality is that like all man-made products and processes, glass has imperfections.



Because the consumer expects glass should be looked through and not looked at, problems arise when a blemish or imperfection is noticed and at that point the they're often no longer able to look past the issue.

When viewing, measuring, understanding the quality of a pane of glass, AS/NZS4667:2000 is the go-to Standard for the New Zealand glass industry. The intent of this guide is to aide in the understanding of the Clauses within this Standard that help explain what is acceptable and what is not.

Citing the Standard often offers little comfort to the consumer, because once the imperfection has been seen, it cannot be unseen, whether its within tolerance or not.



Scope

This guide applies to the assessment of the visible quality of glass used in NZ buildings and only to the surfaces that remain visible after the installation of the pane into its supporting frame.

What MBIE Has to Say...

In 2015 the Ministry of Building, Innovation and Employment published a "[Guide to tolerances, materials and workmanship in new residential construction](#)", designed to provide assistance to contractors and home owners who maybe unsure of what constitutes a defect under the Building Act of 2004.

The guide outlines what constitutes acceptable levels of workmanship in standard domestic construction types, under normal conditions.



Section 5 of the guide specifically relates to Windows & Doors. Naturally glass also sits within this section and includes the following table.

GLASS	
✘	Glass is blemished, marked (e.g. scratches, mortar, stain, or paint spatter), distorts view or is poorly cut.
✘	Inconsistent tint colour or appearance across the window.
✘	The glass does not conform to the requirements set out in AS/NZS 4666:2012 ¹⁹ , or AS/NZS 4667:2000 ²⁰ .
✘	Where designers have provided appropriate information surrounding the end location of the glazing units, including wind zones and altitude to the manufacturer, Newtons Rings and excessive visual distortion are manufacturing defects.
✔	Brewsters fringes and preferential wetting patterns are not considered a defect.

And this note...

The normal viewing position is at a distance of ≥ 2 m for both glass (with a sky background) and painted non-concrete surfaces (see Inspecting surfaces and fixtures).



What the Standards Say...

The Clauses within the Standards typically refer to the factory testing of glass rather than in-situ inspection. However, whilst the MBIE document suggests a viewing distance of greater than 2m, which are based on the viewing distances for paintwork and other surface finishes, the viewing distances described within the Standards are appropriate, as explained below.

Method of Viewing - Defect Inspection

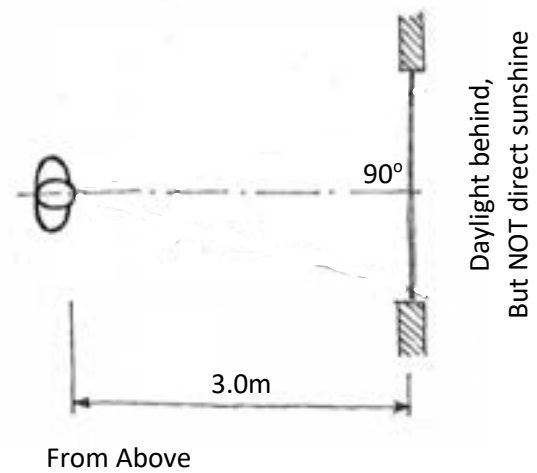
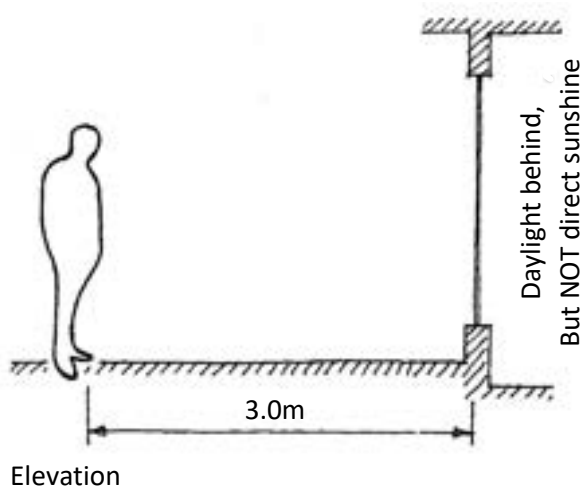

Not only is the viewing distance and angle important, so too is the type of daylight you're looking into. Certainly, the glass can be viewed in the daylight, but it must not be direct sunshine.





Primary Vision Area

International standards suggest any pane being assessed for defects shall meet the following criteria;

- i) defects viewed in the primary vision area are **unacceptable** if visible from a distance of 3m, as described in the Method of Viewing section.
- ii) defects viewed in the secondary vision area are may be acceptable depending on the type and size of the defect.
- iii) The Rebate area is the part of the pane that is contained within the frame and is not visible.

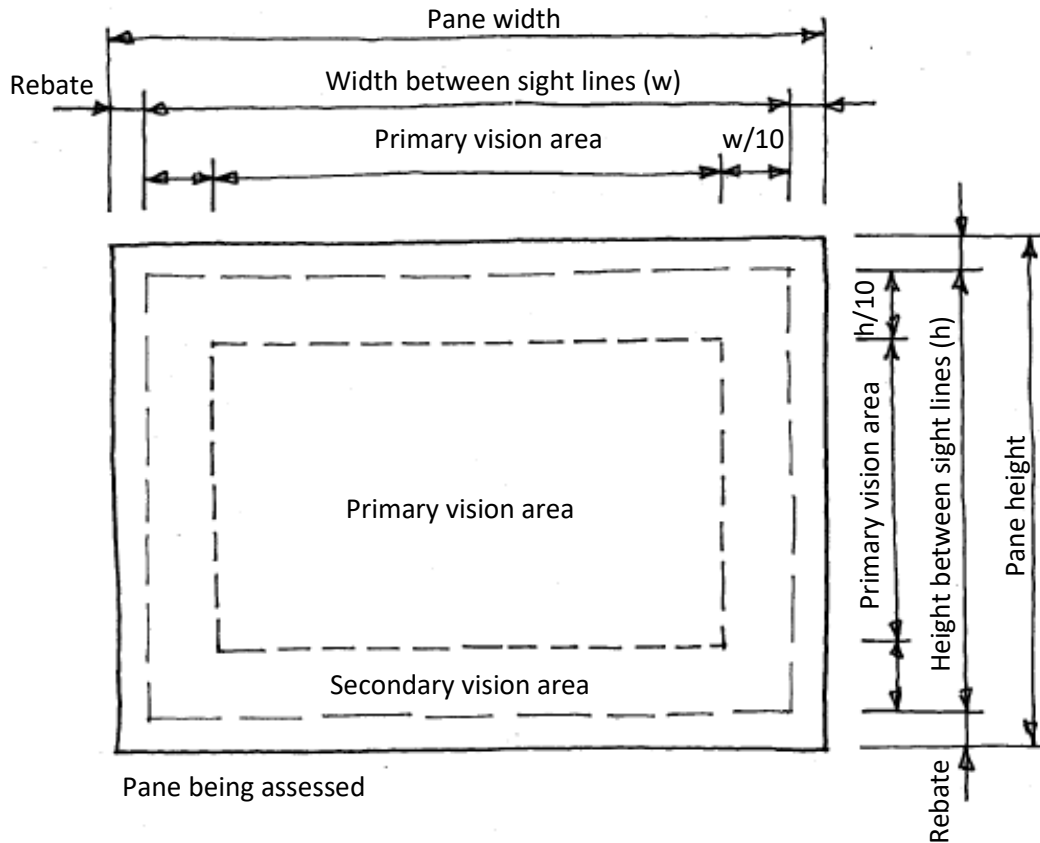



AS/NZS4667:2000 - Quality Requirements for Cut-to-Size and Processed Glass

As noted previously, AS/NZS4667:2000 is the go-to Standard for the New Zealand glass industry. The Standard describes a number of possible defects that may occur in glass, but the common consumer complaints revolve around, marks, scratches and distortion. The following two clauses are the most appropriate and provide a guide to the quality that can be expected of the glass.

Note: single and double glazing will have similar levels of visual quality.

Before inspection for blemishes, the glass should be cleaned in accordance with the manufacturer's recommendations.

Clause 9.2.5 - Scratches, scars and rubs

Inspect the glass held in a perpendicular position using daylight without direct sunlight, or with a background light suitable for observing any imperfections. Imperfections shall not be visible from **a distance of 3m**.

Clause 9.2.7 - Distortion

The manufacturer and the customer shall agree on the following:

- a) The tolerances for surface distortion.

Note: Clause 2.5 of AS/NZS2208:1996 refers to the flatness requirements for safety glazing materials in buildings.

- b) The method of measurement and the magnitude of distortion.

Surface distortion shall not be measured within a 150mm band from the edge of the glass panel, as distortion in this area is a result of localized warpage.

Note: Glass surface distortion is a normal attribute of heat-treated glass and varies between manufacturers. The distortion becomes pronounced as the angle of view becomes more acute.

*Roller wave distortion can only be measured on panes **greater than 1100mm** wide. It is measured at least 300mm from the glass edge and the peak to peak distortion should not exceed 0.2mm.*

P.S. – The NZ glass industry has agreed to a more stringent tolerance for distortion as noted later in this bulletin.

AS/NZS4666:2012 - Insulating Glass Units

This Standard sets out the requirements and guidelines for the long term type test, glazing, periodic manufacturing testing and other associated aspects to do with insulated glass units (IGU's).

Note: single and double glazing will have similar levels of visual quality, although there are some characteristics that are specific to IGU's.

The following descriptions have been derived from "Appendix D - Visual Characteristics" of this Standard.



Deflection and Reflection

Small changes in temperature and pressure can cause glass to bow outwards or inwards and change the images reflected from the window. These distortions are an inevitable consequence of the laws of physics and cannot be eliminated.

***Note:** Excessive deflections are not considered a defect unless the customer has provided the end location and altitude of the glazing, and design wind pressures to the supplier for design of the IGU.*

Newton's Rings

In a large IGU, the two glass panes may be displaced by air pressure until they come close to touching in the middle. When this happens, Newton's Rings are an optical phenomenon, which are roughly circular and coloured bands, may form in the centre of the unit.

Newton's Rings can easily be avoided in large IGUs by allowing cavities that suit the design wind pressures.

***Note:** Newton's Rings are a naturally occurring phenomenon and are not usually considered to be a defect.*

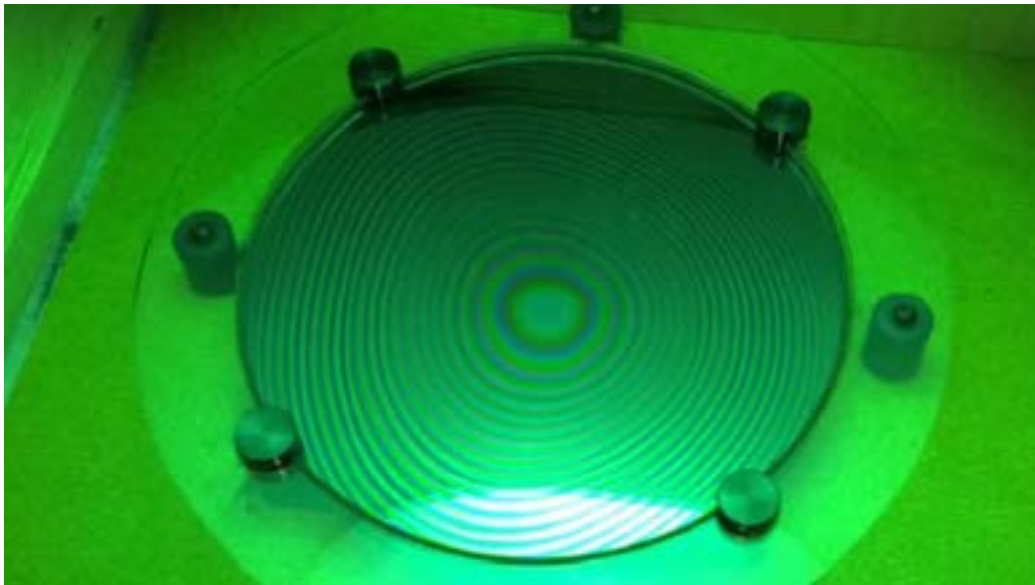



Brewster's Fringes

Under certain lighting conditions, Brewster's fringes are sometimes visible when multiple light reflections occur in IGUs of high-quality float glass panes of identical thickness (for example 4 mm float on 4 mm float from the same stock sheet). These interference fringes are faint coloured bands of irregular shapes, and they can be located anywhere over the surface.

Note: Brewster's fringes are not considered a defect.

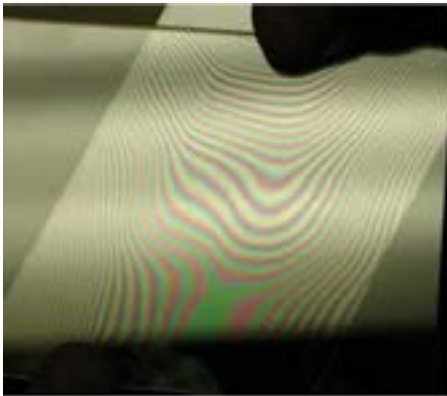

Preferential Wetting Patterns

These patterns are visible when the glass surface gets wet from rain, condensation or washing and are caused by manufacturing tools and equipment, and devices such as vacuum lifters and separation pads, that came into contact with the glass during manufacture, handling and installation.

Although these tools and equipment, and devices did not leave a visible residue on the glass, they have changed the surface condition, and this creates patterns on the glass surface when it gets wet.

These patterns do not affect the functionality, performance or longevity of the units, and may dissipate in time.

Note: These patterns are not considered a defect.





Photoelasticity or Anisotropy

The variation of stress across the surface of toughened glass from the toughening process can result in light and dark areas being visible (sometimes known as 'leopard spots') when polarised light is incident on the glass. This phenomenon is known as photoelasticity.

The photoelastic effect is an inherent characteristic of all heat-treated glass, and is more noticeable on thicker glass, coated glass, and laminated glass through polarized glasses. The effect may be accentuated when there are two or more layers of toughened glass in an IGU.

Note: Photoelasticity or anisotropy is not considered a defect.





Distortion in Toughened Glass - Bow, Roller Waves and Edge Kink

Glass surface distortion from bow, roller waves, and edge kink is a *normal* attribute of heat-treated toughened glass. It distorts objects when viewed through or reflected from the glass, and it is more pronounced when viewed from an angle.

Note: Non-coated glass may have different tolerances to coated and specialty glasses.

Acceptable bow limits are provided below from Table 3 of AS/NZS 4667:2000.

TABLE 3
BOW (FLATNESS) LIMITS FOR GLASS OF STANDARD
NOMINAL THICKNESS (ALL TYPES)

millimetres

Glass thickness	Horizontal glass dimension		
	0 to 1500	1501 to 3000	3001 to 5000
3	1 in 200	1 in 150	—
4	1 in 200	1 in 150	—
5	1 in 300	1 in 200	1 in 200
6	1 in 350	1 in 250	1 in 200
8	1 in 400	1 in 300	1 in 250
10	1 in 400	1 in 300	1 in 250
12	1 in 400	1 in 300	1 in 250
15	1 in 400	1 in 300	1 in 250
19	1 in 400	1 in 300	1 in 250
25	1 in 400	1 in 300	1 in 250

NOTES:

- 1 Refer to Clause 9 for test methods.
- 2 Flatness measurements shall be checked against a straightedge with the panel standing within 5° of vertical and measurements taken horizontally.
- 3 For non-standard glass thicknesses, interpolation will be required.
- 4 Linear interpolation as defined in AS 1288 shall apply for non-standard thicknesses.

Note: Bow exceeding these limits are considered a defect.

Glass distortion can be pronounced in toughened laminated glass, especially when roller waves and/or edge kinks in the two sheets of glass coincide. Whenever possible, heat treated glass should be installed with the roller waves positioned horizontally across the panels.

New Zealand industry manufacturers agree the tolerances on roller wave and edge kink, should be;

- Roller wave = **0.15mm** measured at least 300 mm from the leading or trailing edge
- Edge kink = **0.30mm** measured at least 300 mm from the leading or trailing Edge

Note: These tolerances may vary dependent on glass type. Consult your manufacturer / supplier if you have any questions.

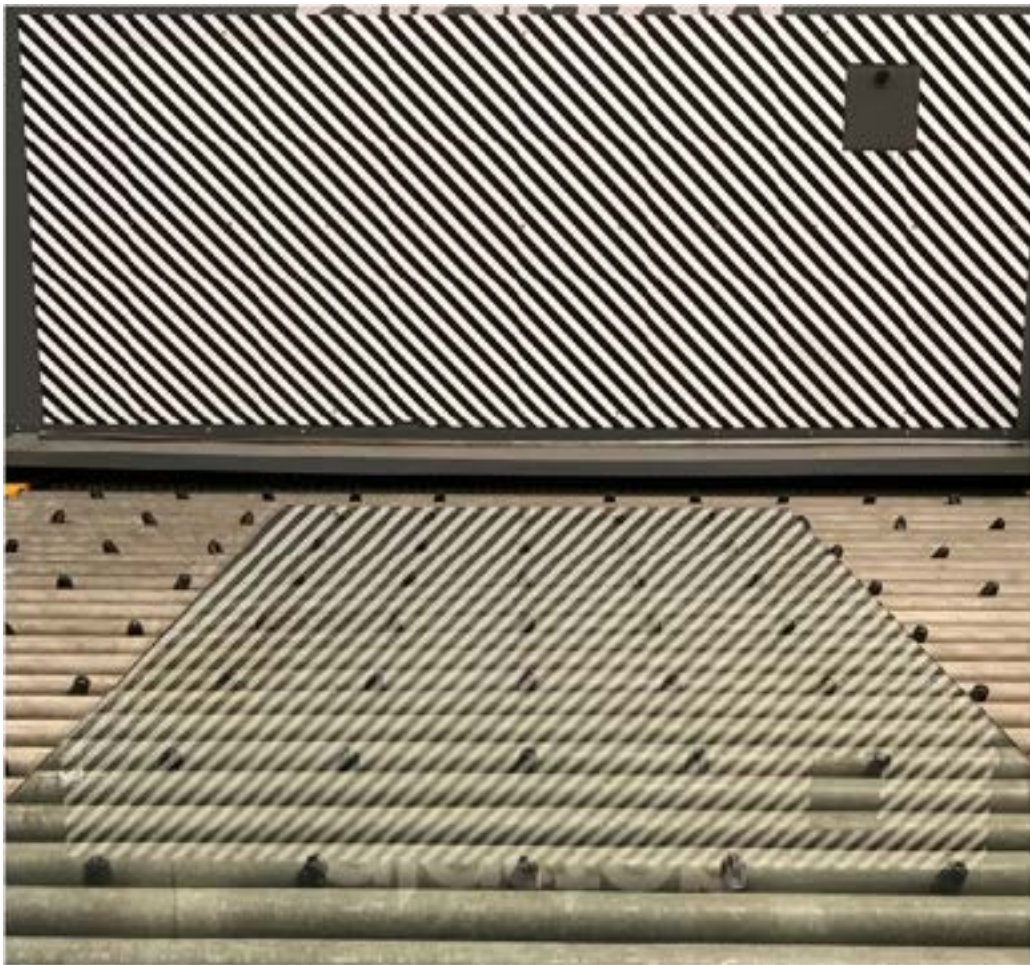

Zebra board used for visual check of glass distortion during manufacture



Roller wave and edge kink can be measured with a roller wave gauge, or a 300 mm steel ruler and feeler gauge as shown on the next page.



Roller wave gauge



Feeler gauge

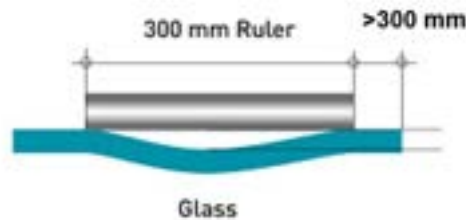

Roller wave

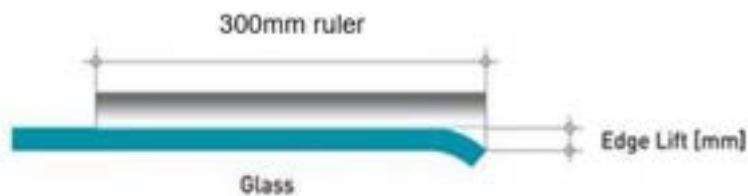

Edge kink

Note: Glass distortion from roller wave and/or edge kink is not considered a defect.



Scratches, Blemishes, Marks and Inclusions

Surface imperfections and inclusions for glass up to 12 mm thick in IGUs are provided by Table 5.5 of AS/NZS 4666:2012, below.

Allowable scars, bubbles, seeds and scratches from this table are provided in the next page for the primary vision zone and the periphery secondary zone.

Scratches to the primary vision area are unacceptable if visible when viewed for not more than 60 seconds in a perpendicular position from a distance of 3m using a daylight background.

Accumulative faults apply to any given glass size.

TABLE 5.5
ALLOWABLE SURFACE IMPERFECTIONS AND INCLUSIONS FOR GLASS UP TO 12 mm NOMINAL THICKNESS INTENDED FOR USE IN RESIDENTIAL INSULATING GLASS UNITS

IGU size mm (Up to)	Central primary vision zone mm	Ream		Scars		Bubbles		Seeds		Scratches	
		Primary mm	Secondary mm	Primary mm	Secondary mm	Primary mm	Secondary mm	Primary mm	Secondary mm	Primary mm	Secondary mm
500 × 350	500 × 350	Nil	Nil	Nil	Nil	Nil	Nil	Nil	Nil	Nil	Nil
750 × 550	650 × 500	Nil	Nil	Nil	Nil	Nil	1 × 0.3	Nil	Nil	Nil	Nil
1000 × 700	900 × 600	Nil	Nil	Nil	Nil	Nil	1 × 0.3	Nil	1 × 0.3	Nil	1 × 50 × 0.75
1250 × 900	1100 × 750	Nil	Nil	Nil	1 × 3	1 × 0.3	2 × 0.3	Nil	1 × 0.3	1 < 50 × 0.5	1 × 50 × 0.75
1500 × 1000	1300 × 850	Nil	Nil	Nil	1 × 3	1 × 0.3	2 × 0.3	Nil	1 × 0.3	1 < 50 × 0.5	1 × 50 × 0.75
2000 × 1200	1800 × 950	Nil	Nil	Nil	1 × 5	1 × 0.3	2 × 0.5	Nil	1 × 0.5	1 < 50 × 0.5	1 × 75 × 0.75
2500 × 1500	2200 × 1200	Nil	Nil	Nil	1 × 5	2 × 0.5	3 × 0.5	Nil	1 × 0.5	1 < 75 × 0.5	1 × 75 × 0.75
3000 × 1800	2700 × 1500	Nil	Nil	Nil	2 × 5	2 × 0.5	4 × 0.5	Nil	2 × 0.5	1 < 75 × 0.5	1 × 75 × 0.75
3500 × 2500	3000 × 2000	Nil	Nil	Nil	2 × 5	3 × 0.5	4 × 0.5	Nil	2 × 0.5	1 < 75 × 0.5	1 × 75 × 0.75

NOTES:

- Scratches to the primary vision area are unacceptable if visible from a distance of 3 m. If detailed inspection is required, glass shall be viewed in a perpendicular position using a daylight background. Glass panes requiring this degree of inspection should not be viewed when they are standing in direct sunlight and the viewing period should not be more than 60 seconds.
- For all coated glass types individual pin holes up to 1.5 mm in diameter are acceptable. In secondary vision areas, individual pinholes up to 2 mm are acceptable. The maximum number of pinholes allowed for panes up to 3 m² of glass is three pinholes, separated by a minimum distance of 500 mm. For each 1 m² of glass over this area one extra pinhole is allowed. A single cluster of pinholes may exist in the secondary vision area providing it consists of no more than five pinholes of less than 0.75 mm in diameter that are not visible from a distance of 3 m. If detailed inspection is required, glass shall be viewed in a perpendicular position using a daylight background. Glass panes requiring this degree of inspection are not to be viewed when they are standing in direct sunlight and the viewing period shall not exceed 60 seconds.
- Measurements of fault sizes are recommended to be performed using a PEAK LUPE seven times magnifier or equivalent.
- Accumulative fault conditions apply to any given glass size, i.e. 1000 mm × 700 mm may contain 1 mm × 3 mm seed, plus one 50 mm × 0.75 mm scratch to the secondary vision area whilst also containing one by less than 50 mm × 0.5 mm scratch to the primary viewing area.
- For units exceeding 3500 mm × 2500mm, the primary vision zone rests 300 mm from all four edges and acceptable fault conditions shall remain the same as for 3500 mm × 2500 mm size units.